

QUICK-LOCK® Wall angles & ceiling edges

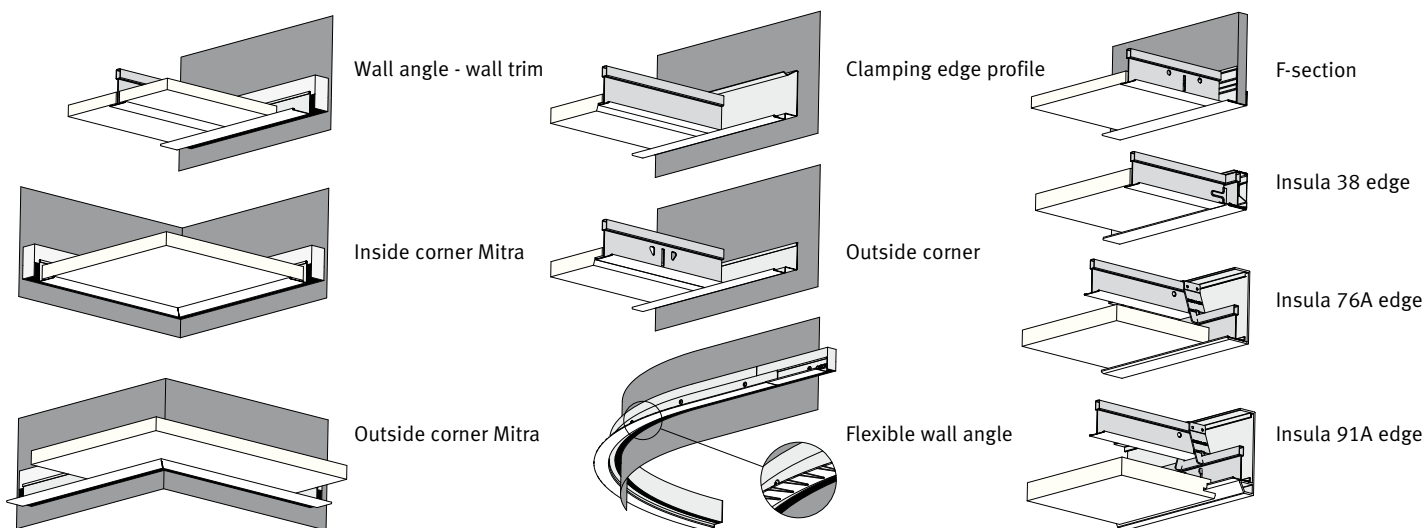

Component, dimensions in mm

Product Nr Description

Length
mm
Pack/
Qty
R- Mtr/
pack
Weight/
pack
Logistic
code

Wall angle 19 x 24 mm

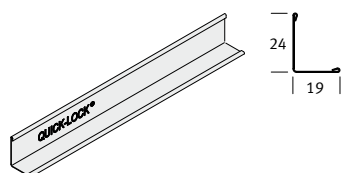

41 33 101	Snow-white	3000	30	90	16.2	A
41 33 119	Snow-white ultra matt	3000	30	90	16.2	A
41 33 535	Snow-white Corro-Plus	3000	30	90	16.2	B
41 33 103	Black RAL 9005*	3000	30	90	16.2	A
41 33 116	Black, ultra matt	3000	30	90	16.2	A
41 33 105	Brushed aluminium	3000	30	90	8.3	A
41 33 111	RAL 9006*	3000	30	90	16.2	A

Wall angle 24 x 24 mm

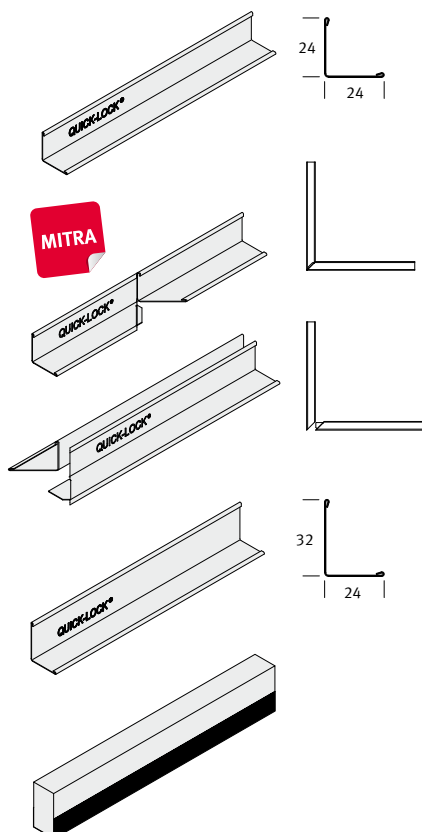

41 33 301	Snow-white	3000	30	90	18.2	A
41 02 010	Snow-white	1500	40	60	12	C
41 33 306	RAL 9010*	3000	30	90	18.2	A
41 01 050	Mitra inside corner 450-2550 mm	3000	30	90	18.2	B
41 01 051	Mitra inside corner 750-750 mm	1500	30	45	9.2	B
41 01 060	Mitra outside corner 1500-1500 mm	1500 (2)	15	45	9.2	B

For wall angle 24 x 24 on size and Mitra in and outside corner wall angles on size see page 41.

Wall angle 32 x 24 mm

41 33 401	Snow-white	3000	30	90	21.8	B
**	Galvanized	3000	30	90	21.8	C

Timber wall trim

42 24 013	Timber, black 18 x 35 mm	3000	10	30	9.4	A
42 24 000	Timber, white 18 x 35 mm	3000	10	30	9.4	B

* RAL-colors: minor deviations to the RAL standard can not be excluded.

** On demand.

QUICK-LOCK® Wall angles & ceiling edges

Component, dimensions in mm

Product Nr Description

Length
mm

Pack/
Qty

R- Mtr/
pack

Weight/
pack

Logistic
code

Shadow moulding

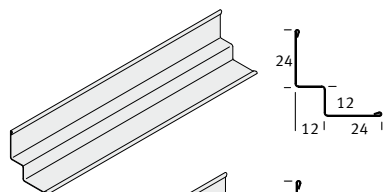

41 40 018 Snow-white, 24 x 12 x 12 x 24 mm 3000 25 75 24.8 A

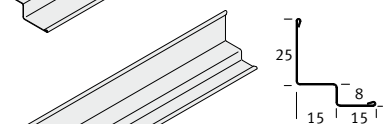

41 40 016 Snow-white, 25 x 15 x 8 x 15 mm 3000 25 75 22.2 A

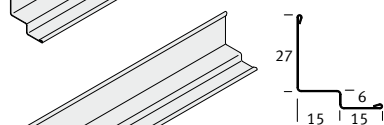

41 40 017 Snow-white, 27 x 15 x 6 x 15 mm 3000 25 75 22.2 A

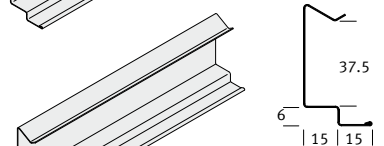

41 33 900 Snow-white, 6 mm 3000 20 60 29 B

Outside corner profile, snow-white

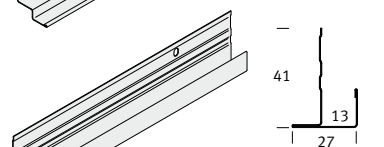

41 33 800 27 x 41 x 13 mm 3000 24 72 26 B

Perforations 300 mm c.t.c.

Aluminum wall angle

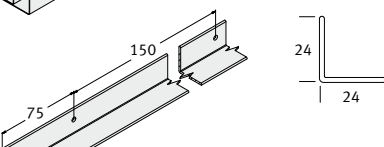

42 00 035 Aluminium 24 x 24 mm, white* 3000 15 45 10 B

Limited bendability. Radius mounting tolerance convex R +/- 250 mm, concave +/- 100 mm.

On request, the aluminum wall angle can be supplied pre-bent in the desired radius.

Flexible wall angle

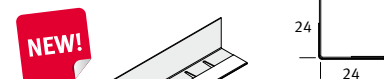

** 24 x 24 mm, wit* 2500 10 25 4.5 B

Bendable and intended for mounting on "convex" walls. Minimum radius 200 mm.

The punched steel profile is covered with flexible white PVC. The punches will come in visible to a limited extent.

Ceiling edge profiles

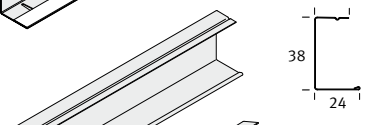

41 41 822 Edge profile U-38 snow-white 3000 18 54 17.4 B

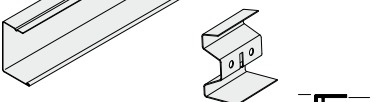

42 06 010 Connector U-38 50 0.7 B

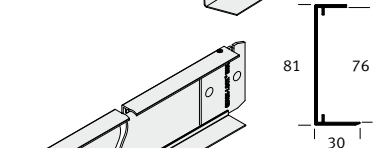

42 60 410 Edge profile U-76A 2400 4 9.6 9.9 B
other lengths see page 26

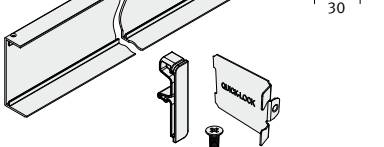

41 60 010 Insula A Edge clips & accessories 25 0.3 B
(2 edge clips per edge, corner)

Column rings

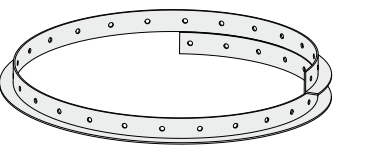

** Aluminium 30 x 20 x 2 mm, white* C

Diameter 135 - 1170 mm

To be cut on the job site

Different shapes and dimensions on demand

* Minor color deviation from snow-white

** On demand.